

A guide to self-injection

This booklet is intended for patients who have been prescribed Xolair® (omalizumab) for severe allergic asthma (SAA).

This medicine is used to prevent asthma from getting worse by controlling symptoms of SAA in adults, adolescents and children (6 years of age and older) who are already receiving asthma medicine, but whose asthma symptoms are not well controlled by medicines such as high-dose steroid inhalers and beta-agonist inhalers.

Children (6–11 years of age) are not expected to self administer Xolair. However, if considered appropriate by their doctor, a caregiver may give them their Xolair injection after proper training.

Always refer to the patient information leaflet for information about your treatment.

Please find full information on how to report a side effect on the last page.

This material was created and funded by Novartis.

 NOVARTIS





Contents

Injecting Xolair at home	4	Autoinjector pen:	
Pre-filled syringe:		Your Xolair autoinjector pen	28
Your Xolair pre-filled syringe	6	Important safety information	30
Important safety information	8	Storing Xolair	32
Storing Xolair	10	Getting ready to inject	33
Getting ready to inject	12	Preparing the Xolair autoinjector pen for use	34
Preparing the Xolair pre-filled syringe for use	14	Now let's get started	36
Now let's get started	15	How to use the Xolair autoinjector pen	40
How to use the Xolair pre-filled syringe	22	Disposal instructions	46
Disposal instructions	27	Potential side effects	48
		Travelling with Xolair	49
		Frequently asked questions	50
		Sources & reporting side effects	52



Injecting Xolair at home

Your doctor or nurse has decided that you are now able to inject Xolair at home. This booklet contains everything you need to know to help you correctly self-inject with the Xolair pre-filled syringe or autoinjector pen.

These instructions should also be followed if you are providing the injections to someone else.

Before injecting at home, you will have been fully trained by a doctor, nurse or pharmacist at your clinic to make sure that you are comfortable with the self-injection procedure.

Please read ALL the way through the instructions before injecting and keep this booklet in a safe place in case you need to refer back to it.

This guide is not intended to take the place of your Xolair leaflet. Please read your Xolair package leaflet carefully before you start using this medicine, as it contains important information for you, such as a full list of possible side effects. If you have any further questions, speak to your doctor, pharmacist or nurse.

Your Xolair pre-filled syringe

- Xolair 300 mg pre-filled syringe is not intended for use in children under 12 years of age
- Xolair 75 mg pre-filled syringe and Xolair 150 mg pre-filled syringe or Xolair powder and solvent for solution for injection may be used in children 6–11 years of age with allergic asthma

The Xolair pre-filled syringe comes boxed and individually sealed in a plastic wrapper. **Do not** open the sealed outer box until you are ready to use this medicine. In addition, **do not** use this medicine if either the seal on the outer box or the seal of the blister is broken, as it may not be safe for you to use.

The boxed syringe should be stored in the refrigerator and removed approximately 30 minutes before your injection to allow it to come to room temperature.

Pre-filled syringe

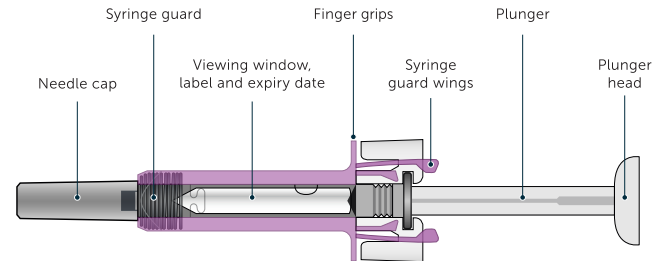

The pre-filled syringe has syringe guards, which are activated to cover the needle after the medicine has been injected. This is intended to protect against accidental needlestick injuries.

Be careful not to touch the syringe guard wings before use. By touching them, the syringe guard may be activated too early.

The needle cap of the syringe may contain a derivative of dry rubber (latex), which should not be handled by individuals who are sensitive to this substance.

Important safety information



Caution: Keep the syringe out of the sight and reach of children.

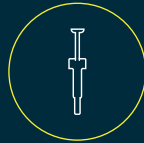

Never leave the syringe lying around where others might tamper with it.



Do not shake the syringe.



Do not use if the syringe has been dropped onto a hard surface or dropped after removing the needle cap.

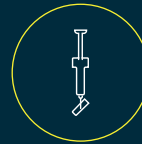

Do not remove the needle cap until just before you give the injection.

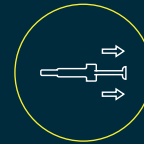

Do not pull back on the plunger.



Do not inject if the pre-filled syringe has been kept out of the refrigerator for more than a total of 48 hours. Dispose of it and use a new pre-filled syringe for your injection.



The syringe cannot be re-used. Dispose of the used syringe immediately after use in a sharps container.

Other things you need for your injection

- Cotton ball or gauze
- Alcohol swab
- Sharps disposal container

Storing Xolair

Your medicine may be kept at a maximum of 25°C for a total of 48 hours during transportation.



Store this medicine sealed in its outer box to protect it from light. Store the boxed syringe in the refrigerator between 2°C and 8°C. **Do not** freeze.



Remember to take the syringe out of the refrigerator and allow it to reach room temperature before preparing it for injection (about 30 minutes).



Leave the syringe in the box to protect it from light. The time that the syringe is kept at room temperature (25°C) before use must not exceed 48 hours.

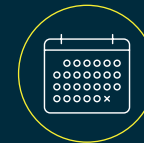

Do not use the syringe after the expiry date which is stated on the outer box and syringe label. If it has expired, return the entire pack to the pharmacy.

Getting ready to inject

The injection site

The injection site is the place on the body where you are going to use the syringe.

- The recommended site is the front of the thighs. You can also use the lower abdomen, but **not** within 5 centimetres around the navel (belly button)
- If you need to give more than one injection for the full dose, choose a different injection site each time you inject. Make sure your injections are at least 2 cm apart
- **Do not** inject into areas where the skin is tender, bruised, red or hard. Avoid areas with scars or stretch marks
- If a caregiver is giving the injection, the outer upper arms may also be used
- There are several possible sites that you can use for your injections. Choose the sites that are the most comfortable for you

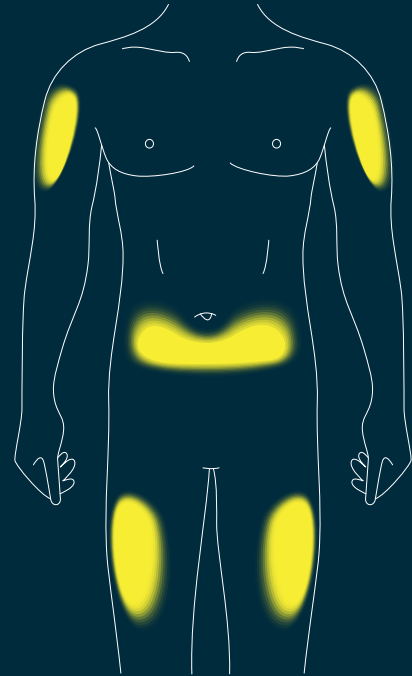

Preparing the Xolair pre-filled syringe for use

Your Xolair dose is tailored specifically for you and is calculated using your body weight and the level of IgE in your blood. If your weight changes significantly you should speak to your doctor or nurse as they may need to recalculate your dose.

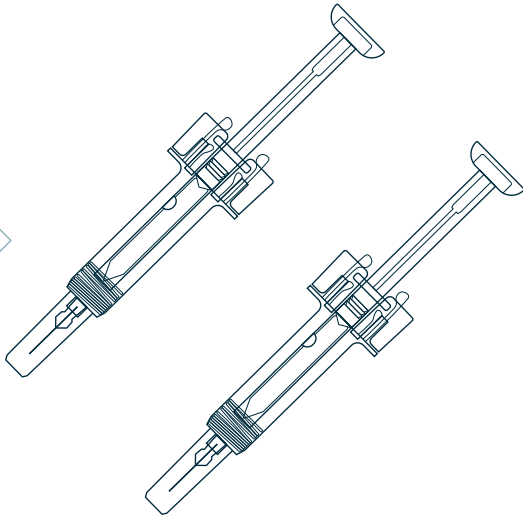

Now let's get started

1

Take the box containing the syringe out of the refrigerator and leave it **unopened** for about 30 minutes so that it reaches room temperature (leave the syringe in the box to protect it from light).

Note: If you need more than one pre-filled syringe (one pre-filled syringe per carton) to deliver your full dose, take all the cartons out of the refrigerator at the same time.

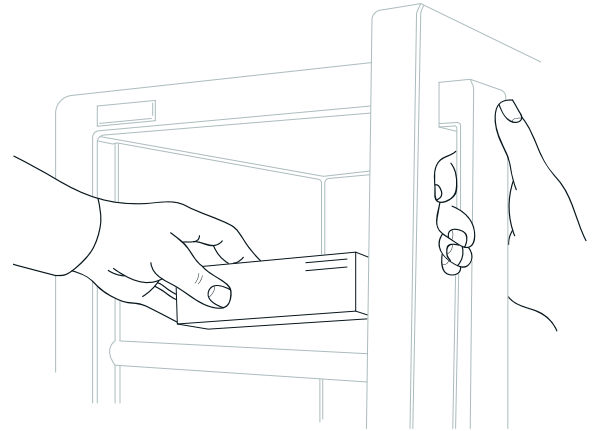



2

When you are ready to use the syringe, wash your hands thoroughly with soap and water.

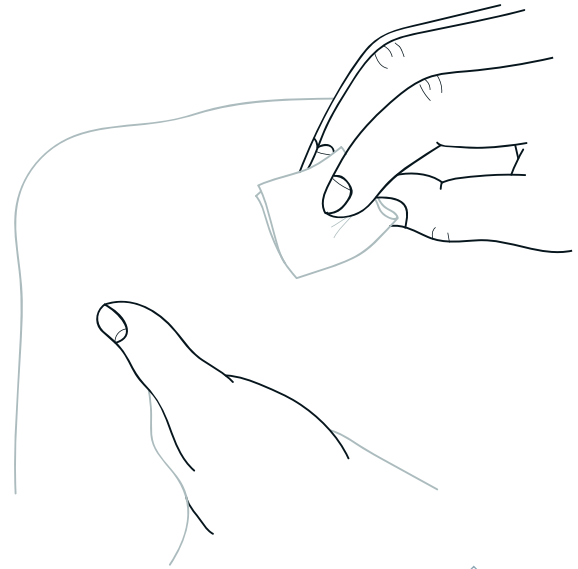

3

Clean the injection site with an alcohol swab. Leave it to dry before injecting. **Do not** touch or blow on the cleaned skin before injecting.

4

Remove the plastic tray from the box and peel back the paper cover. Gripping the middle of the purple syringe guard, lift the syringe out of the tray. Be careful not to touch the syringe guard wings, as this may activate the syringe guard too early.

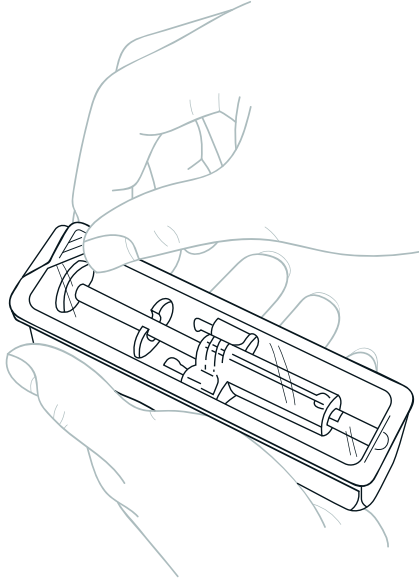

5

Inspect the syringe. The liquid should be clear to slightly cloudy. Its colour may vary from colourless to pale brownish-yellow. You may see an air bubble, which is normal. **Do not** use if the syringe is broken or if the liquid looks cloudy or distinctly brown, or contains particles. In all these cases, return the entire pack to the pharmacy.

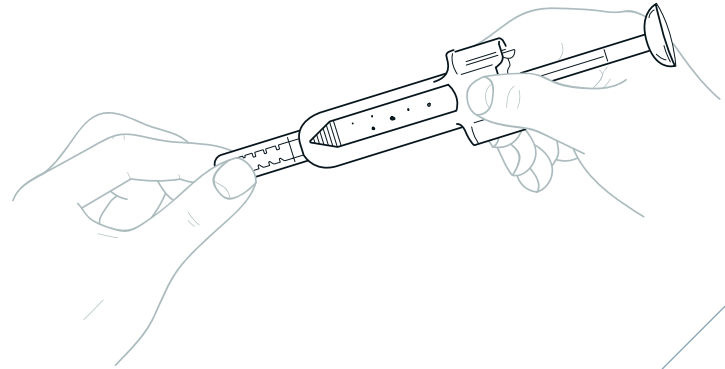

6

Holding the syringe horizontally, look into the viewing window to check the expiry date printed on the label. Be careful not to touch the syringe guard wings.

Note: It is possible to rotate the inner part of the syringe assembly so that the label can be read in the viewing window.

Do not use if the product has expired. In this case, return the entire pack to the pharmacy.

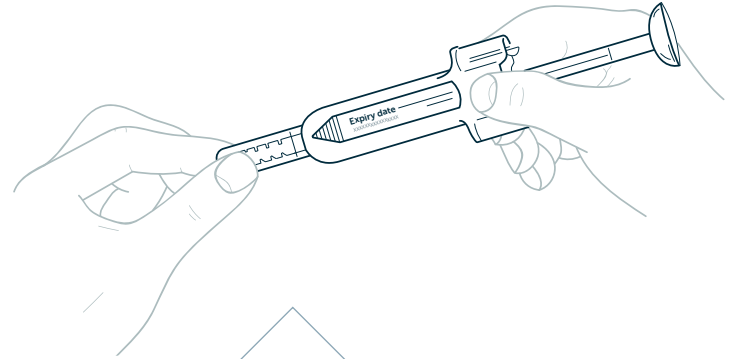

How to use the Xolair pre-filled syringe

1

Carefully remove the needle cap from the syringe. Discard the needle cap. You may see a drop of liquid at the end of the needle. This is normal.

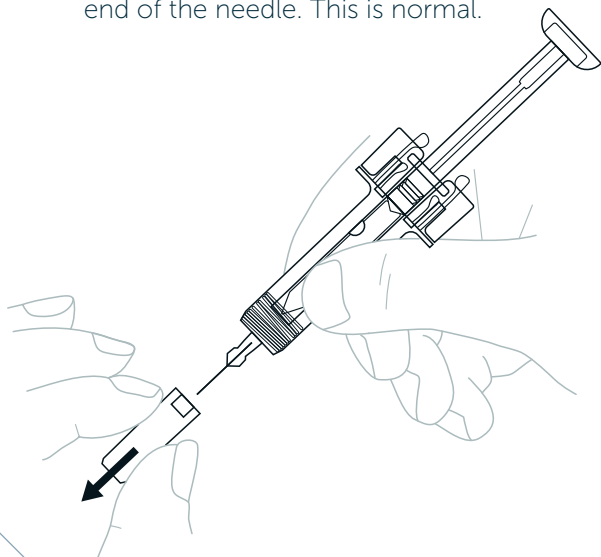

2

Gently pinch the skin at the injection site and hold the pinch throughout the injection. With the other hand insert the needle into the skin at an angle of approximately 45 degrees as shown. **Do not** press the plunger while inserting the needle.

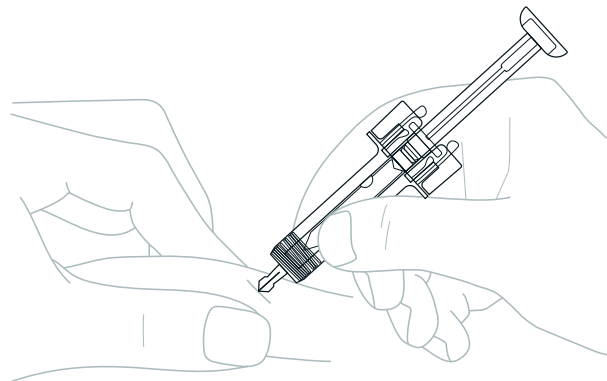

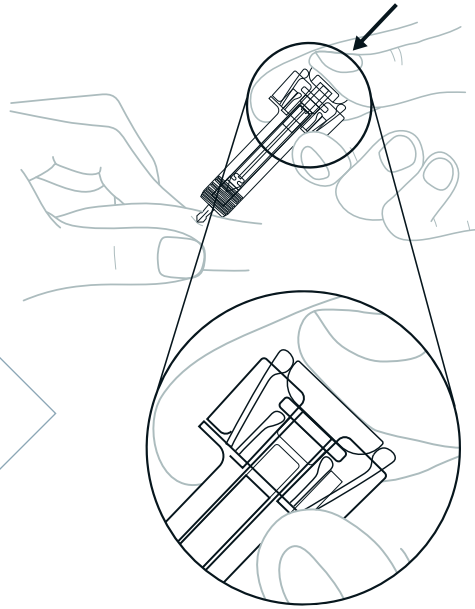

3

Hold the syringe by the finger grips with your thumb on the plunger. **Slowly** depress the plunger **as far as it will go** so that the plunger head is completely between the syringe guard wings.

4

Keep the plunger fully depressed while you carefully lift the needle straight out from the injection site.

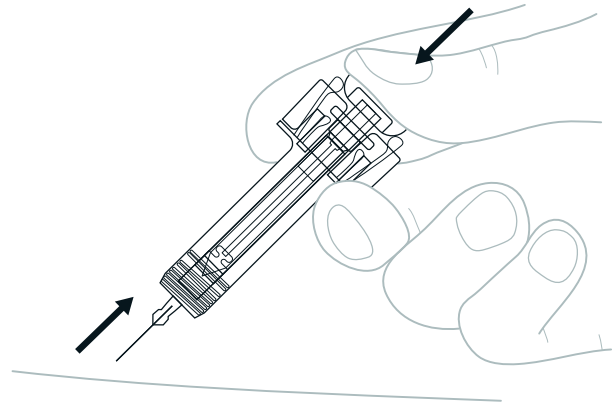

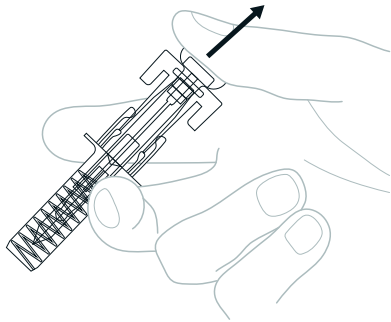

5

Slowly release the plunger and allow the syringe guard to automatically cover the exposed needle.

There may be a small amount of blood at the injection site. You can press a cotton ball or gauze over the injection site and hold it for 30 seconds. **Do not** rub the injection site. You may cover the injection site with a small adhesive dressing, if needed.

Note: If you need more than one pre-filled syringe to deliver your full dose, throw away the used pre-filled syringe as described. Repeat the steps for all the pre-filled syringes needed to deliver your full dose. Carry out the injections immediately one after another. Make sure the injections are at least 2 cm apart.

Disposal instructions

Dispose of the used syringe immediately in a sharps container (closable, puncture resistant container).

For the safety and health of you and others, needles and used syringes **must never** be re-used. Any unused medicinal product or waste material should be disposed of in accordance with local requirements. **Do not** throw away any medicines via wastewater or household waste. Ask your pharmacist how to throw away medicines you no longer use.

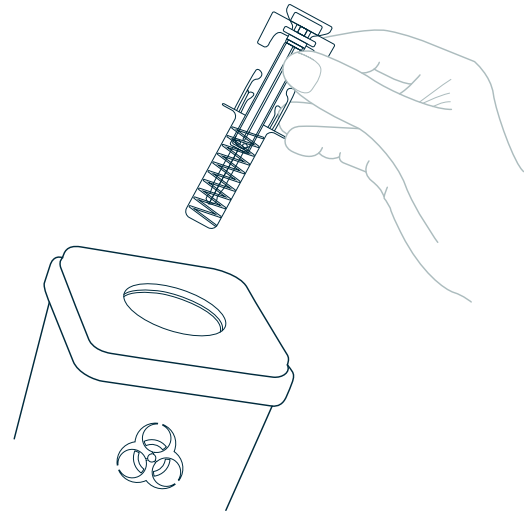

Your Xolair autoinjector pen

- Xolair pre-filled pens are not intended for use in children under 12 years of age
- Xolair 75 mg pre-filled syringe and Xolair 150 mg pre-filled syringe or Xolair powder and solvent for solution for injection may be used in children 6–11 years of age with allergic asthma

This Xolair pen is intended to be used for patients ages 12 and up.

Be sure that you read and understand these "Instructions for Use" before injecting with the Xolair pen. Talk to your doctor if you have any questions.

If your doctor decides that you or your caregiver may be able to give your injections of Xolair at home, ensure that your doctor or nurse shows you or your caregiver how to prepare and inject with the Xolair pen before you use it for the first time.

Before use

After use

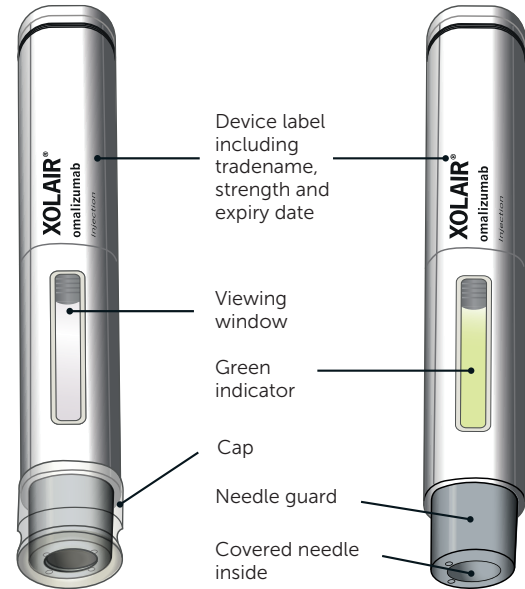

Important safety information



Do not use the pen if the seal on the outer carton is broken.



Do not use if the pen has been dropped after removing the cap.



Do not try to re-use or take apart the pen.



Do not try to reattach the cap once it has been taken off.



Do not inject if the pen has been kept out of the refrigerator for more than a total of 48 hours. Dispose of it (see Page 46) and use a new pen for your injection.



Do not touch or push the needle guard as you could get injured. Touching or pushing on the needle guard could cause a needlestick injury.

You will need the following supplies (not included in the carton)

- Alcohol wipe
- Cotton ball or gauze pad
- Sharps disposal container
- Adhesive plaster

Storing Xolair



Store in a refrigerator (2°C–8°C). The carton containing the pen can be stored for a total time of 48 hours at room temperature (25°C) before use.

Do not freeze.



Keep the pen in the original carton until ready to use in order to protect from light.



Caution: Keep the syringe out of the sight and reach of children.

Getting ready to inject

You should inject into the front of the thighs or the lower stomach area but not the area 5 cm around the belly button.

Do not inject into skin that is tender, bruised, red, scaly or hard or into areas with scars or stretch marks.

Note: If you need more than one pen to deliver your full dose, make sure your injections are at least 2 cm apart.

If a caregiver, doctor or nurse is giving the injection, they may also inject into the outer upper arm.

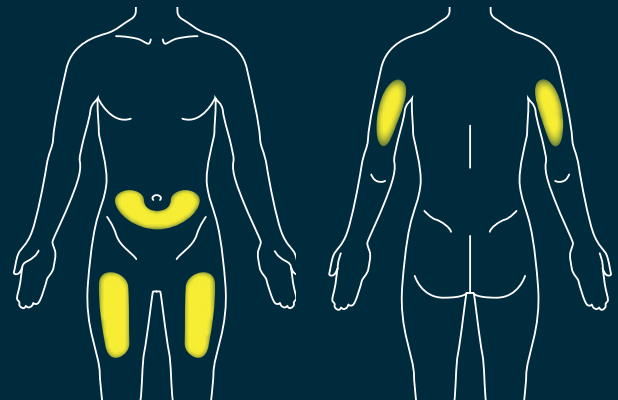

Preparing the Xolair autoinjector pen for use

Xolair pens are available in 3 dose strengths (one pen in each carton). These instructions are to be used for all 3 dose strengths.

Depending on the dose prescribed to you by your doctor, you may need to select one or more pens, and inject the contents of them all in order to deliver your full dose.

Contact your doctor if you have questions about the Dosing Table.



Dose	Number of autoinjectors needed for the dose	75 mg	150 mg	300 mg
75 mg	1 blue			
150 mg	1 purple			
225 mg	1 blue + 1 purple			
300 mg	1 grey			
375 mg	1 blue + 1 grey			
450 mg	1 purple + 1 grey			
525 mg	1 blue + 1 purple + 1 grey			
600 mg	1 grey + 1 grey			

Now let's get started

1

Take the carton containing the pen out of the refrigerator and leave it **unopened** so that it reaches room temperature (minimum 30 minutes).

Note: If you need more than one pen (one pen in each carton) to deliver your full dose (see Dosing Table on page 35), take all the cartons out of the refrigerator at the same time.

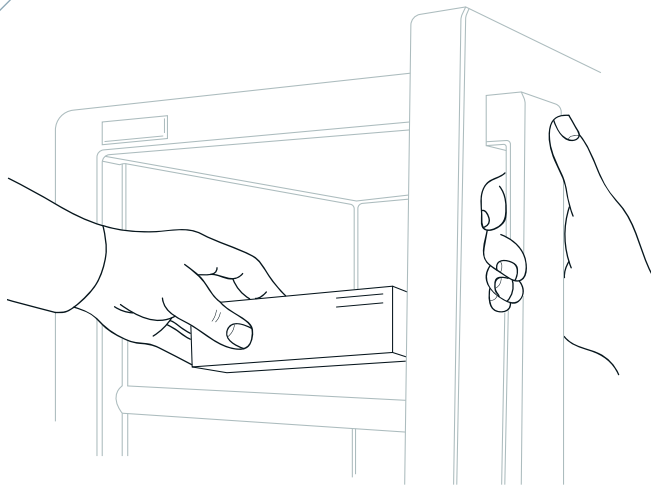

2

You will need the following supplies (not included in the carton):

- Alcohol wipe
- Cotton ball or gauze pad
- Sharps disposal container
- Adhesive plaster

3

Take the pen out of the outer carton. **Do not** remove the cap until you are ready to inject.

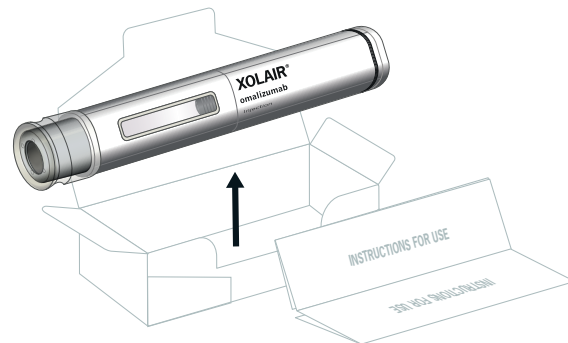

4

Look through the viewing window of the pen. The liquid inside should be clear to slightly cloudy. Its colour may vary from colourless to pale brownish-yellow. You may see air bubbles in the liquid, which is normal.

- **Do not** use the pen if the liquid contains particles, or if the liquid looks distinctly cloudy or distinctly brown.
- **Do not** use the pen if it looks damaged.
- **Do not** use the pen after the expiry date (EXP), which is printed on the pen label and carton.

In all of these cases, contact your doctor, nurse or pharmacist.

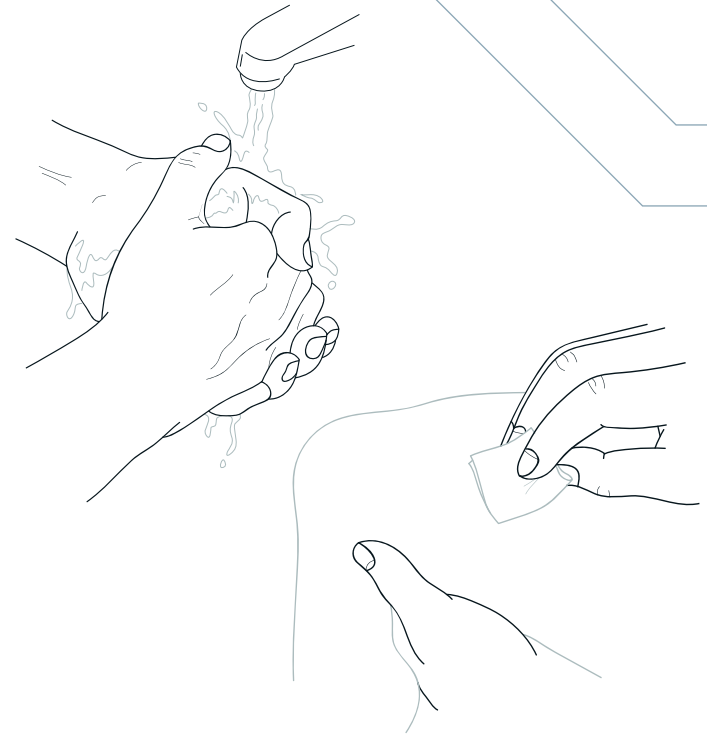
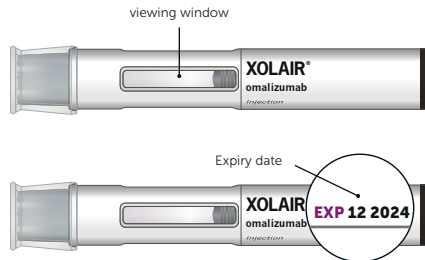

5

Clean your hands. Clean the chosen injection site with an alcohol wipe. Leave it to dry before injecting. **Do not** touch or blow on the cleaned skin before injecting.

How to use the Xolair autoinjector pen

1

Pull the cap straight off in the direction of the arrow. **Do not** put the cap back on. Throw away the cap.

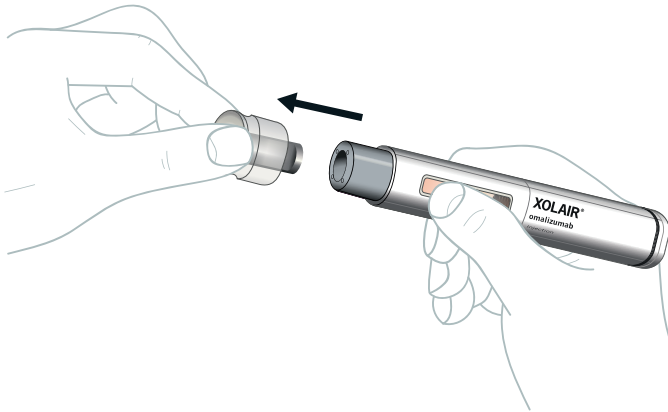

2

Hold the pen comfortably **with the needle guard directly against the skin**. The pen should be at a 90° angle to the skin as shown.

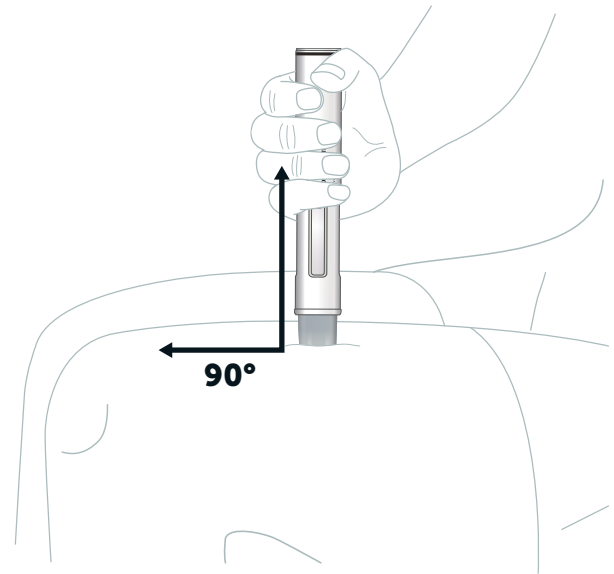

3

Push and hold the pen firmly against the skin. Listen for the **1st click** which indicates that the injection has started.

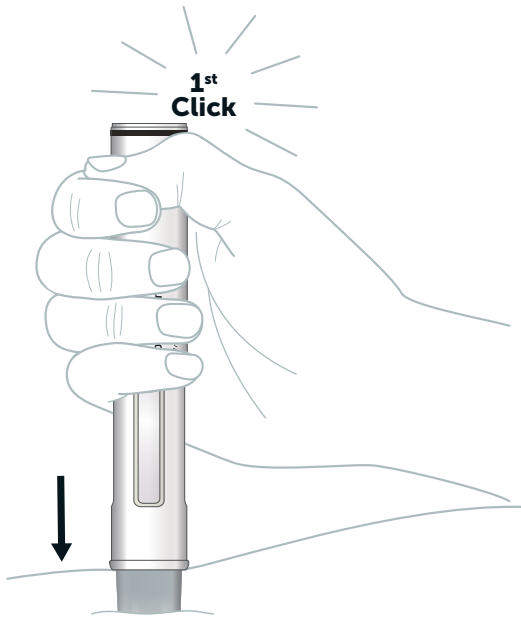

4

Keep holding the pen firmly down against the skin. The **green indicator** shows the progress of the injection.

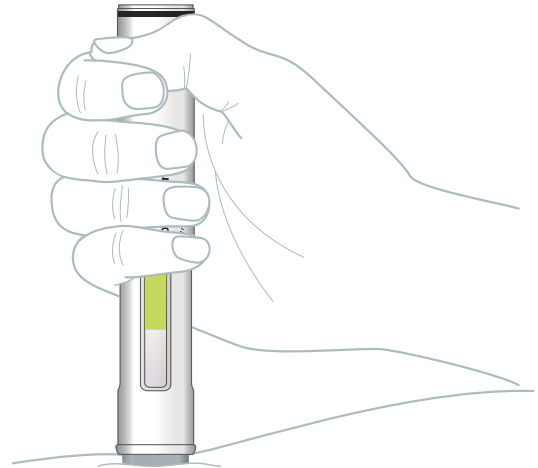

5

Listen for the **2nd click**. This indicates the injection is **almost** complete.

Keep holding the pen in position until the green indicator has stopped moving to make sure the injection is complete.

Remove the pen from the skin. The needle is automatically covered by the needle guard. The injection is now complete.

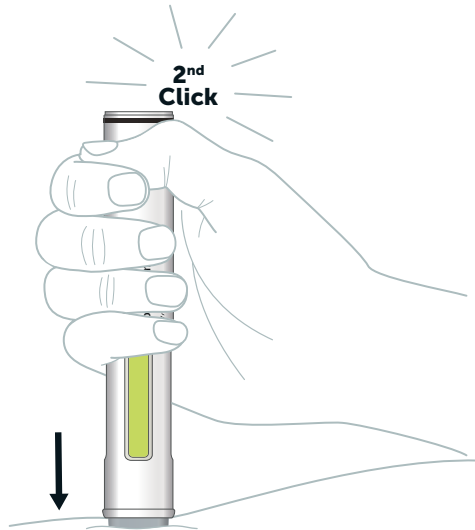

6

If the green indicator has not completely filled the viewing window, contact your doctor or nurse. There may be a small amount of blood at the injection site. You can press a cotton ball or gauze pad over the injection site until any bleeding stops. **Do not** rub the injection site. If needed, cover your injection site with a small adhesive plaster.

Note: If you need more than one pen to deliver your full dose, throw away the used pen as described in the disposal instructions. Repeat these steps again for all the pens needed to deliver your full dose. Carry out the injections immediately one after another. Make sure the injections are at least 2 cm apart.

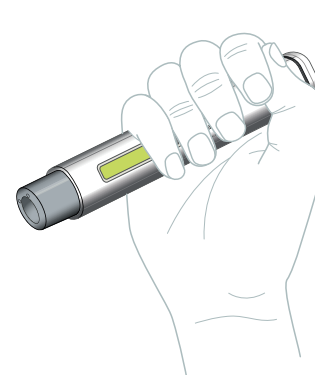

Disposal instructions

Put the used pen in a sharps disposal container (i.e., a puncture-resistant closable container, or similar) right away after use.

Talk to your doctor or pharmacist about proper disposal of the sharps disposal container. There may be local regulations for disposal.



Potential side effects

Like all medicines, Xolair can cause side effects, although not everybody gets them.

For example, around 1 in 10 people experience injection site reactions such as pain, swelling, itching or redness. More than 1 in 10 children may also experience fever as a very common side effect.

The side effects caused by Xolair are usually mild to moderate, but can occasionally be serious.

Look out for signs of allergic reactions and other serious side effects. Serious side effects include severe allergic reactions (including anaphylaxis) and systemic lupus erythematosus. You must look out for signs of these conditions while you use Xolair. **Seek medical help immediately** if you notice any signs indicating a severe allergic reaction or other serious side effects. Such signs are listed under "Serious side effects" in section 4 of the patient information leaflet.

For further information about potential side effects, please refer to the patient information leaflet in the box with your injection.

Travelling with Xolair

The shelf life of Xolair includes potential temperature excursions, like transporting it home from the hospital or taking it with you when you travel. Your medicine may be kept at a maximum of 25°C for a total of 48 hours (2 days).

If flying, you should check your airline's carry-on policy regarding medications as you may need to supply a doctor's letter. **Do not** pack your Xolair in your checked luggage.

Frequently asked questions

- **Will I have to use the same dose of Xolair forever?**

Your Xolair dose is tailored specifically for you and is calculated using your body weight and the level of IgE in your blood. If your weight changes significantly, you should speak to your doctor or nurse as they may need to recalculate your dose.

- **What happens if I forget to inject my Xolair?**

If you forget to inject your Xolair, administer the next dose as soon as you remember. Then talk to your doctor or nurse to discuss when you should inject the next dose.

- **How do I store Xolair?**

Xolair should be stored in the refrigerator, between 2°C and 8°C. **Do not** freeze. Store it in the original packaging to protect it from light. Always keep your medicine out of sight and reach of children.

- **How do I dispose of my used syringes and autoinjector pens?**

Dispose of used syringes and used autoinjector pens immediately in a sharps container.

- **Can I use Xolair if I'm pregnant?**

If you are pregnant or are planning to have a baby, ask your doctor for advice before using Xolair and they will discuss with you the benefits and potential risks of using Xolair during pregnancy. If you become pregnant whilst on treatment, tell your doctor immediately. If you are breast-feeding or plan to breast-feed, ask your doctor for advice before using Xolair.

- **Is the dosing different for children?**

The dose for children aged 6 years and older is also individually calculated using body weight and IgE levels rather than age. If a child's weight changes significantly, speak to the doctor or nurse as their dose may need to be recalculated. Children (6–11 years of age) are not expected to self administer Xolair. However, if considered appropriate by their doctor, a caregiver may give them their Xolair injection after proper training.

- **What happens if I inject more Xolair than my recommended dose?**

If you have accidentally used more Xolair than prescribed, immediately contact your doctor or nurse for further advice.

- **Should I use Xolair if I'm feeling unwell?**

Feeling unwell shouldn't affect your Xolair injection, but contact your doctor or nurse for more information about contraindications and precautions.

For further information, please visit the Xolair SAA Members of Public page.

Sources

Xolair Patient Information Leaflet.

Xolair Summary of Product Characteristics

Reporting side effects

If you get side-effects with any medication you are taking, talk to your doctor, pharmacist or nurse.

This includes any possible side effects not listed in the information leaflet that comes in the pack.

You can report side effects via the Yellow Card Scheme at www.mhra.gov.uk/yellowcard. By reporting side effects, you can help provide more information on the safety of your medication.

For full details about Xolair, please refer to your patient information leaflet.

Date of preparation: July 2024
UK | 431702

 NOVARTIS

omalizumab